

ASSEMBLY INSTRUCTIONS

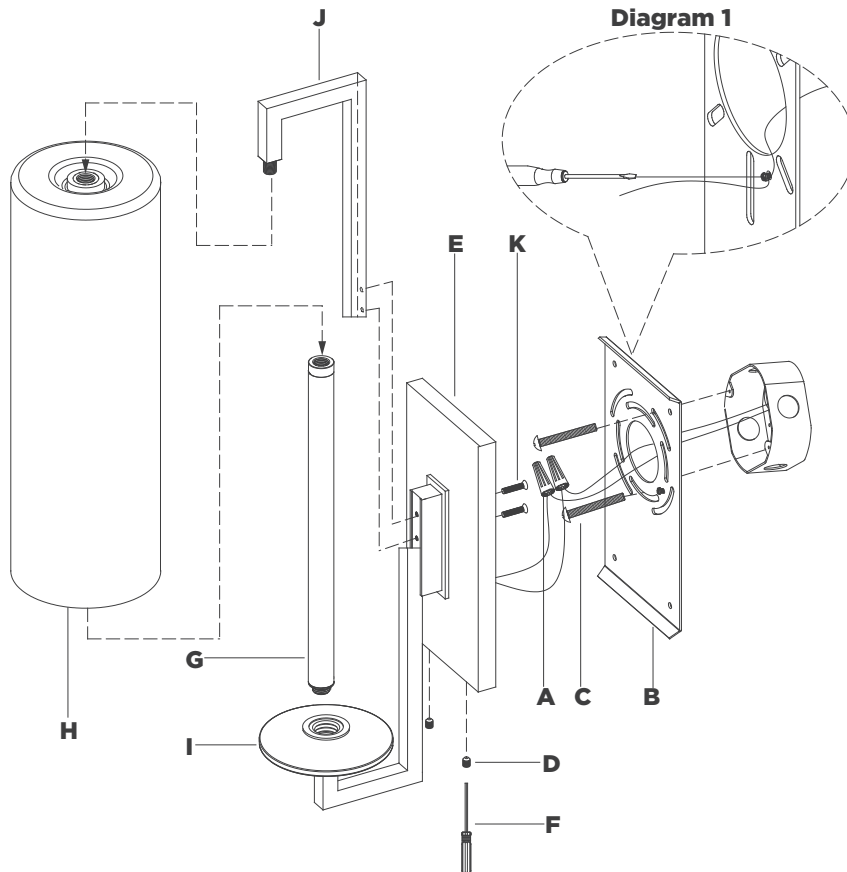

Bowen 16" Linear Bath Sconce

Item # IKF2520

NOTICE:

This light fixture should be installed in accordance with all applicable, local installation codes, and by a person familiar with the construction and operation of it, as well as the hazards involved. Inspect item and contents carefully. If any damage or defect is found, do not install. Retain all packaging material until installation is complete and approved.

TOOLS REQUIRED (NOT INCLUDED):

Phillips Screwdriver

Slotted Screwdriver

1. Carefully remove all parts from the box. Place on a clean, soft surface.
2. Remove mounting plate **(B)** from fixture **(E)** by removing set screws **(D)** using provided screwdriver **(F)**.
3. Install mounting plate **(B)** to the junction box and secure with mounting screws **(C)**.
4. Thread LED source **(G)** to base **(I)**.
5. Thread fixture arm **(J)** to shade **(H)**.
NOTE: Do not overtighten otherwise glass shade could be damaged.
6. Place shade **(H)** onto base **(I)**, then fix fixture arm **(J)** to fixture **(E)** by securing with screws **(K)**.
7. Connect supply ground wire (usually green or bare copper) around the green grounding screw (see diagram 1). Tighten.
NOTE: It is imperative that the fixture is grounded.
8. Connect fixture neutral wire (white) to the supply neutral wire (usually white) using wire nut **(A)**.
9. Connect fixture hot wire (black) to the supply hot wire (usually black) using wire nut **(A)**.
CAUTION: Do not reverse the hot and neutral connections.
10. Make sure all wire connections are tight, then carefully tuck into the junction box.

ASSEMBLY INSTRUCTIONS

Bowen 16" Linear Bath Sconce

Item # IKF2520

NOTICE:

This light fixture should be installed in accordance with all applicable, local installation codes, and by a person familiar with the construction and operation of it, as well as the hazards involved. Inspect item and contents carefully. If any damage or defect is found, do not install. Retain all packaging material until installation is complete and approved.

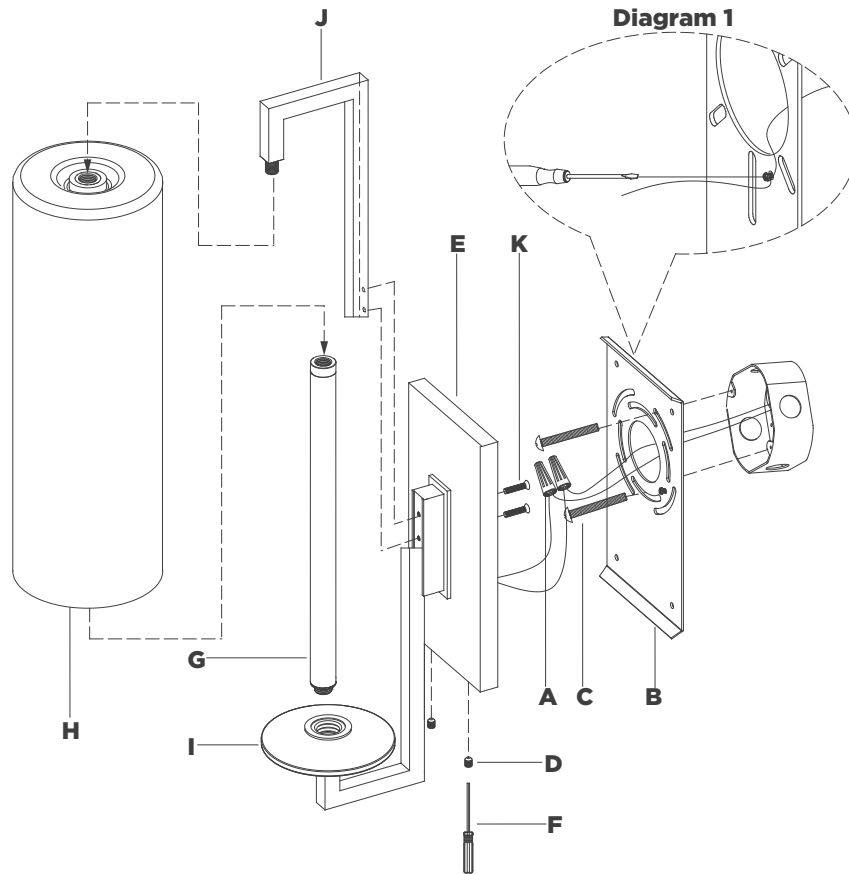

11. Install fixture **(E)** to mounting plate **(B)** and secure with set screws **(D)** using provided screwdriver **(F)**.

CARE INSTRUCTIONS: Clean only with a soft dry cloth or feather duster. Do not use abrasive or chemical agents.