

ASSEMBLY INSTRUCTIONS

Utopia 42" Ring Chandelier

Item # KW5046

NOTICE:

This light fixture should be installed in accordance with all applicable, local installation codes, and by a person familiar with the construction and operation of it, as well as the hazards involved. Inspect item and contents carefully. If any damage or defect is found, do not install. Retain all packaging material until installation is complete and approved.

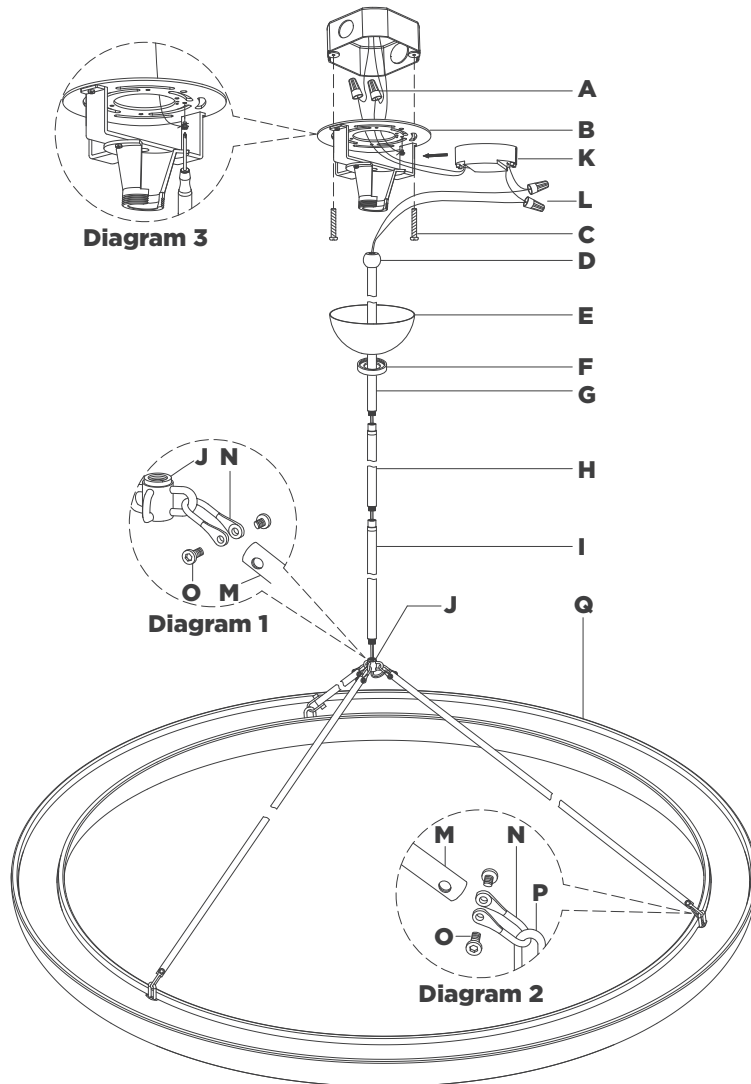

TOOLS REQUIRED (NOT INCLUDED):

Phillips Screwdriver Slotted Screwdriver Wire Strippers
Wire Cutters

1. Carefully remove all parts from the box. Place on a clean, soft surface.
2. Remove mounting plate **(B)** from canopy **(E)** by removing collar ring **(F)**.
3. Install mounting plate **(B)** to the junction box and secure with mounting screws **(C)**.
4. Install rods **(M)** to hooks on fixture loop **(J)** and hooks **(P)** on fixture frame **(Q)** by securing "U" shape links **(N)** using screws **(O)** (see diagram 1 & 2).
5. Feed electrical wires through bottom rod **(I)** and connect to fixture body **(J)**. Repeat for middle rod **(H)**, connecting to bottom rod **(I)**.
6. Continue feeding wires through collar ring **(F)**, canopy **(E)** and top rod **(G)**.
7. Holding fixture upright, slide collar ring **(F)** and canopy **(E)** down and rest on fixture body **(J)**. Then connect top rod **(G)** to middle rod **(H)**.
NOTE: Slide components down slowly to avoid damage.
8. Hang fixture swivel ball **(D)** to the center of mounting plate **(B)**.
9. Cut excess wires, being sure to leave enough to reach the junction box. Separate wires and strip insulation on each 5/8".

ASSEMBLY INSTRUCTIONS

Utopia 42" Ring Chandelier

Item # KW5046

NOTICE:

This light fixture should be installed in accordance with all applicable, local installation codes, and by a person familiar with the construction and operation of it, as well as the hazards involved. Inspect item and contents carefully. If any damage or defect is found, do not install. Retain all packaging material until installation is complete and approved.

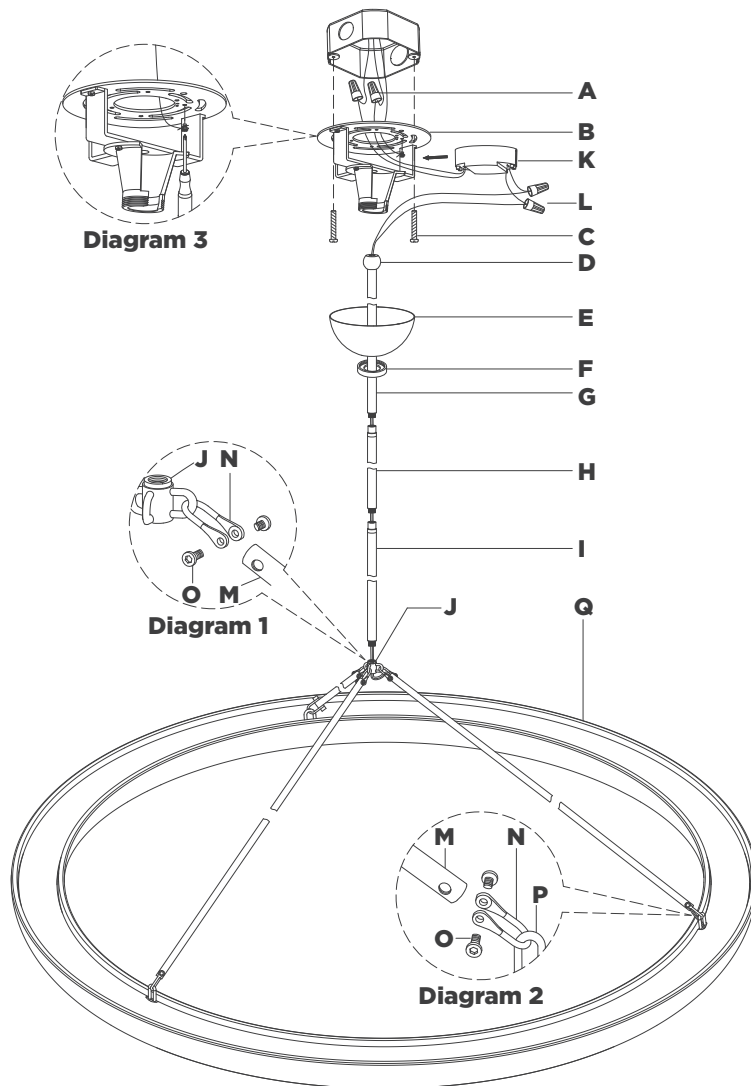

10. Connect fixture neutral wire (black) to driver **(K)** output wire (black) using wire nut **(L)**.
 11. Connect fixture hot wire (red) to driver **(K)** output wire (red) using wire nut **(L)**.
 12. Connect supply ground wire (usually green or bare copper) around the green grounding screw (see diagram 1). Tighten.
- NOTE:** It is imperative that the fixture is grounded.
13. Connect driver **(K)** input neutral wire (white) to the supply neutral wire (usually white) using wire nut **(A)**.
 14. Connect driver **(K)** input hot wire (black) to the supply hot wire (usually black) using wire nut **(A)**.
- CAUTION:** Do not reverse the hot and neutral connections.
15. Make sure all wire connections are tight, then carefully tuck into the junction box.
 16. Insert driver **(K)** into the mounting plate **(B)** bracket.
 17. Install canopy **(E)** to mounting plate **(B)** and secure with collar ring **(F)**.

CARE INSTRUCTIONS: Clean only with a soft dry cloth or feather duster. Do not use abrasive or chemical agents.