

ASSEMBLY INSTRUCTIONS

Option 1: Wall Mounted

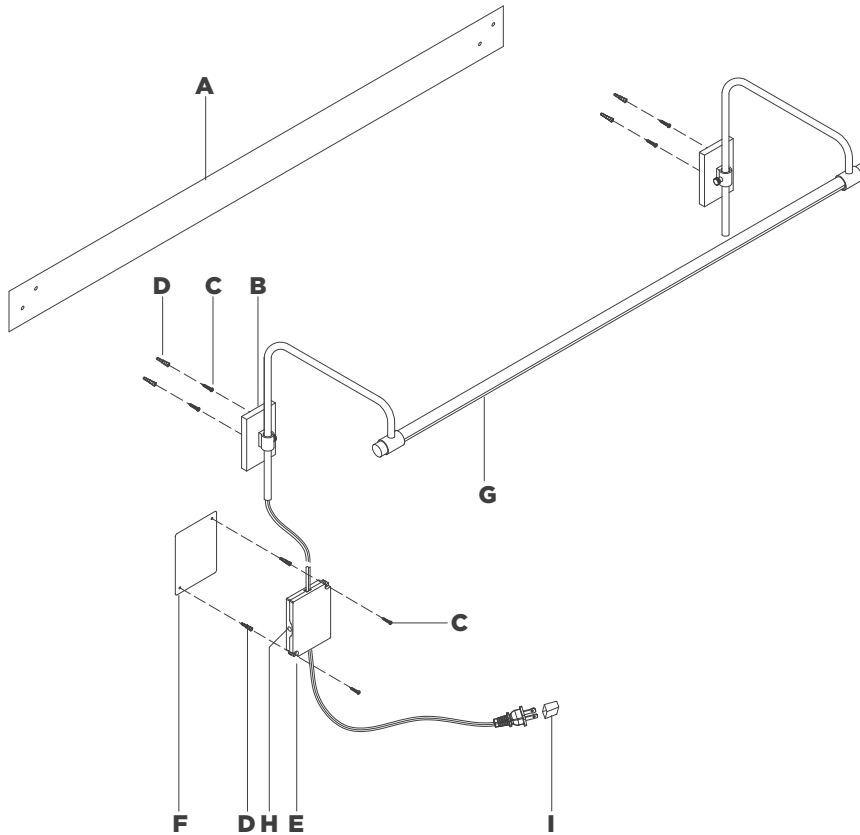

Kidd 30" Frame Mount Picture Light

Item # TOB2613

NOTICE:

This light fixture should be installed in accordance with all applicable, local installation codes, and by a person familiar with the construction and operation of it, as well as the hazards involved. Inspect item and contents carefully. If any damage or defect is found, do not install. Retain all packaging material until installation is complete and approved.

TOOLS REQUIRED (NOT INCLUDED):

Pencil

Hammer

Drill

1. Carefully remove all parts from the box. Place on a clean, soft surface.
2. Using card template **(A)** as a guide, mark anchor positions.
3. Drill holes in the marked positions with a drill bit slightly smaller than the anchor. Carefully insert anchors **(D)** using a hammer.
4. Secure wood screws **(C)** to anchors **(D)**, leaving 1/8" of exposed thread in order to hang fixture.
5. Hook fixture **(B)** to wood screws **(C)**.
6. Determine driver location. Mark anchor positions using provided card template **(F)**.
7. Drill holes in the marked positions with a drill bit slightly smaller than the anchor. Carefully insert anchors **(D)** using a hammer.
8. Attach driver **(E)** to anchors **(D)** with screws **(C)**.
9. Loosen adjustment knobs **(J)** to adjust fixture arm to desired height, then tighten adjustment knobs **(J)** (see diagram 1).
10. Adjust shade **(G)** to desired angle.
11. Remove protective cover **(I)** from plug.
12. Plug into electrical outlet and test the fixture.
13. Test the lamp.

Dimmer switch operation: Touch dimmer **(H)** to adjust between high, medium, low and off settings.

CARE INSTRUCTIONS: Clean only with a soft dry cloth or feather duster. Do not use abrasive or chemical agents.

VISUAL COMFORT & Co.



ASSEMBLY INSTRUCTIONS

Option 2: Picture Frame Mounted

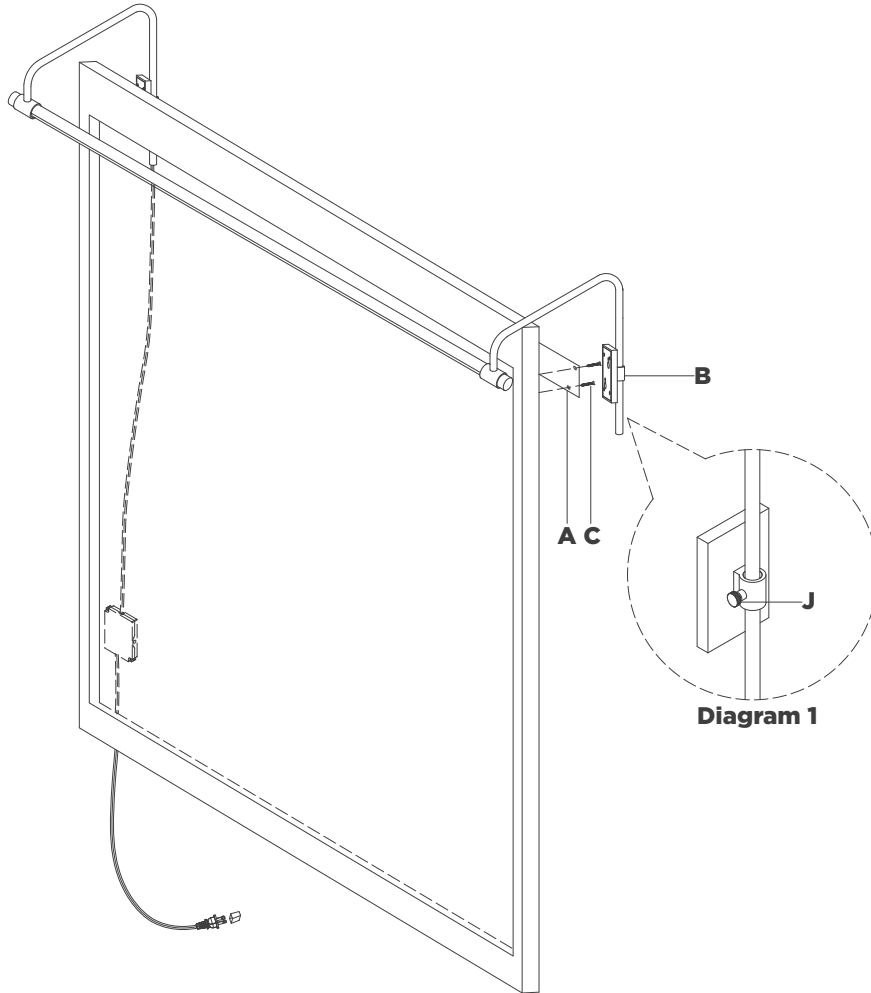

Kidd 30" Frame Mount Picture Light

Item # TOB2613

NOTICE:

This light fixture should be installed in accordance with all applicable, local installation codes, and by a person familiar with the construction and operation of it, as well as the hazards involved. Inspect item and contents carefully. If any damage or defect is found, do not install. Retain all packaging material until installation is complete and approved.

TOOLS REQUIRED (NOT INCLUDED):

Pencil

Hammer

Drill

1. Carefully remove all parts from the box. Place on a clean, soft surface.
2. Loosen adjustment knobs (**J**), rotate backplate to face outward toward picture frame. Adjust fixture arm to desired height, then tighten adjustment knobs (**J**) (see diagram 1).
3. Using card template (**A**) as a guide, mark screw positions on picture frame.
4. Secure wood screws (**C**) to backside of picture frame, leaving 1/8" of exposed thread to hang fixture.
NOTE: Picture frame thickness will vary. Select appropriate size wood screws to mount light directly to picture frame. Pre-drill as necessary.
5. Hook fixture (**B**) to wood screws (**C**).
6. Mount picture frame with attached light to the wall.
NOTE: If applicable, attach driver to wall behind picture frame in desired location.
7. Follow the wall mounted instructions to complete the remaining installation steps.

CARE INSTRUCTIONS: Clean only with a soft dry cloth or feather duster. Do not use abrasive or chemical agents.